

Sources of the Magnetic Field

- Moving charges – currents
- Ampere's Law
- Gauss' Law in magnetism
- Magnetic materials

Biot-Savart Law

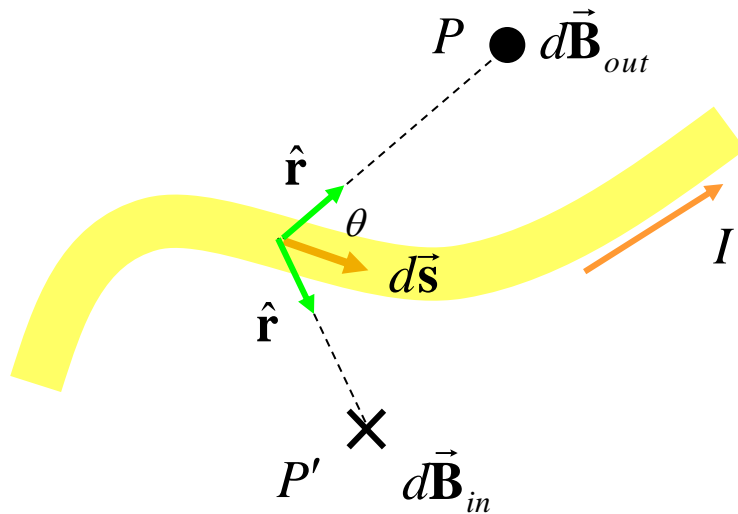

$$\vec{d\mathbf{B}} \perp d\vec{s}$$

$$\vec{d\mathbf{B}} \perp \hat{r}$$

$$dB \propto \frac{1}{r^2}$$

$$dB \propto I$$

$$dB \propto ds$$

$$dB \propto \sin \theta$$

$$d\vec{\mathbf{B}} = \frac{\mu_0}{4\pi} \frac{I d\vec{s} \times \hat{r}}{r^2}$$

$$\vec{\mathbf{B}} = \frac{\mu_0 I}{4\pi} \int \frac{d\vec{s} \times \hat{r}}{r^2}$$

$\mu_0 = 4\pi \times 10^{-7} \text{ T.m/A}$
permeability of free space

Magnetic Field Surrounding a Thin, Straight Conductor

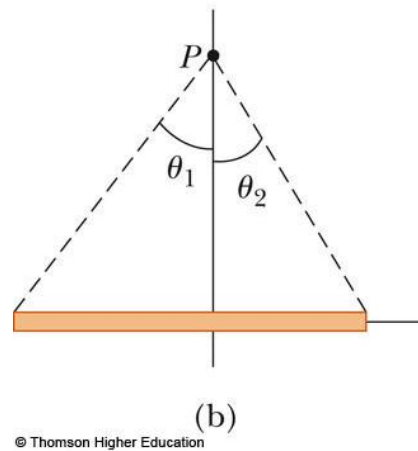
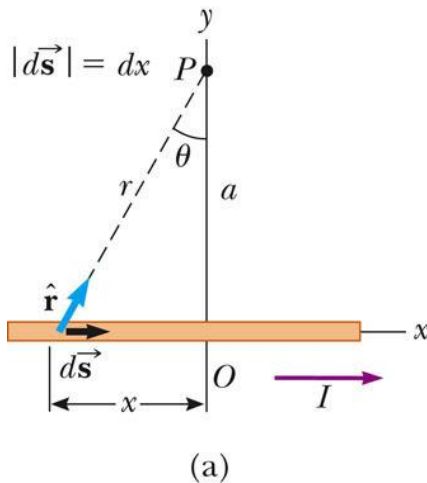

$$d\vec{s} \times \hat{r} = \hat{k} |ds \times \hat{r}| = \hat{k} dx \cos \theta$$

$$d\vec{B} = (dB)\hat{k} = \frac{\mu_0 I}{4\pi} \frac{dx \cos \theta}{r^2} \hat{k}$$

$$dB = \frac{\mu_0 I}{4\pi} \frac{dx \cos \theta}{r^2}$$

$$r = \frac{a}{\cos \theta}$$

$$x = -a \tan \theta$$

$$dx = -a \sec^2 \theta d\theta = -\frac{a d\theta}{\cos^2 \theta}$$

$$dB = \frac{\mu_0 I}{4\pi} \frac{a \cos^2 \theta \cos \theta d\theta}{a^2 \cos^2 \theta} = \frac{\mu_0 I}{4\pi a} \cos \theta d\theta$$

$$B = \frac{\mu_0 I}{4\pi a} \int_{\theta_1}^{\theta_2} \cos \theta d\theta = \frac{\mu_0 I}{4\pi a} (\sin \theta_1 - \sin \theta_2)$$

If the wire is very long,
 $\theta_1 \approx -90^\circ$
 $\theta_2 \approx 90^\circ$ then

$$B = \frac{\mu_0 I}{2\pi a}$$

Field Due to a Circular Arc of Wire

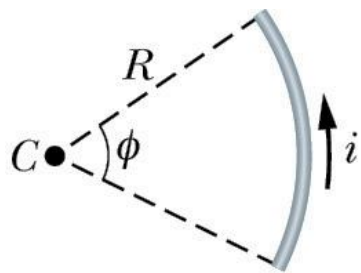

(a)

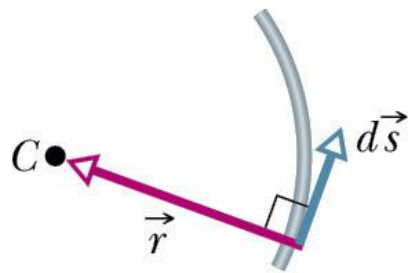

(b)

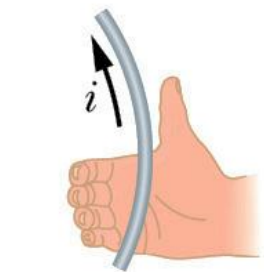
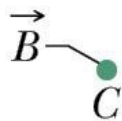

(c)

$$dB = \frac{\mu_0}{4\pi} \frac{id s \sin 90^\circ}{R^2}$$

$$ds = R d\phi'$$

$$B = \int dB = \frac{\mu_0 i}{4\pi R} \int_0^\phi d\phi'$$

$$B = \frac{\mu_0 i \phi}{4\pi R}$$

$$B = \frac{\mu_0 i}{2R}$$

Full Circle ($\phi = 2\pi$)

Magnetic Force Between Two Parallel Conductors

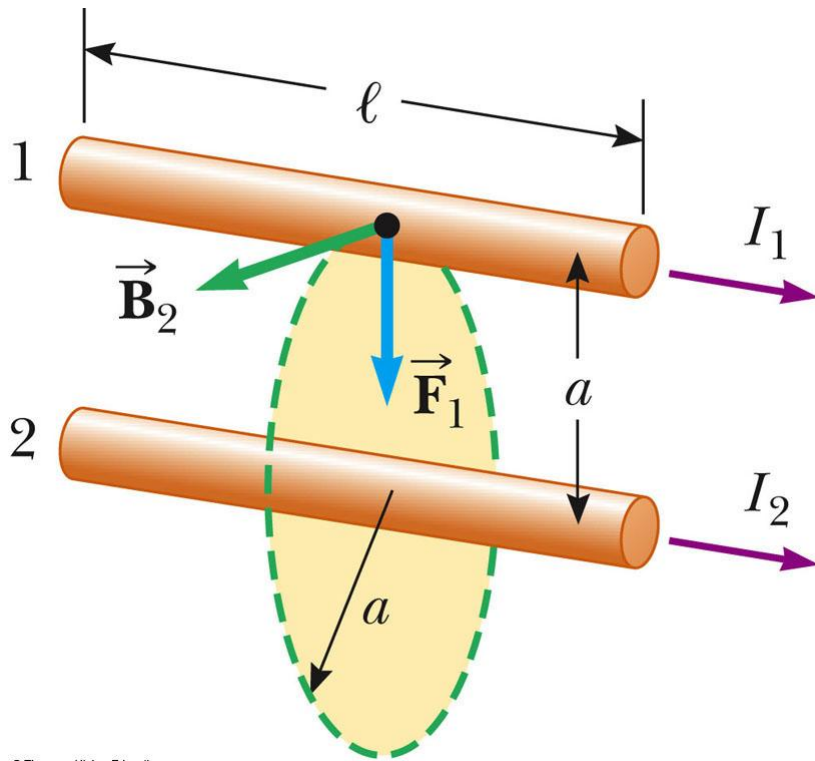

$$F_1 = I_1 l B_2 = I_1 l \left(\frac{\mu_0 I_2}{2\pi a} \right) = \frac{\mu_0 I_2 I_1 l}{2\pi a}$$

$$F_1 = F_2 = F_B$$

$$\frac{F_B}{l} = \frac{\mu_0 I_2 I_1}{2\pi a}$$

Concept Question

On a computer chip, two conducting strips carry charge from P to Q and from R to S . If the current direction is reversed in both wires, the net magnetic force of strip 1 on strip 2

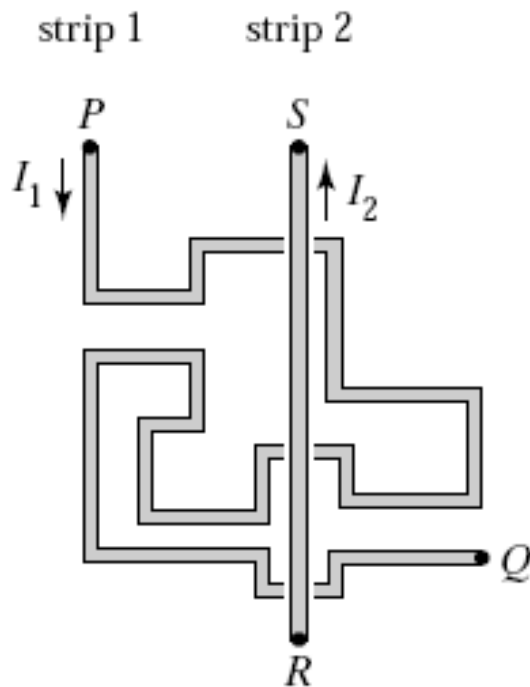

1. remains the same.
2. reverses.
3. changes in magnitude, but not in direction.
4. changes to some other direction.
5. other

Ampère's Law

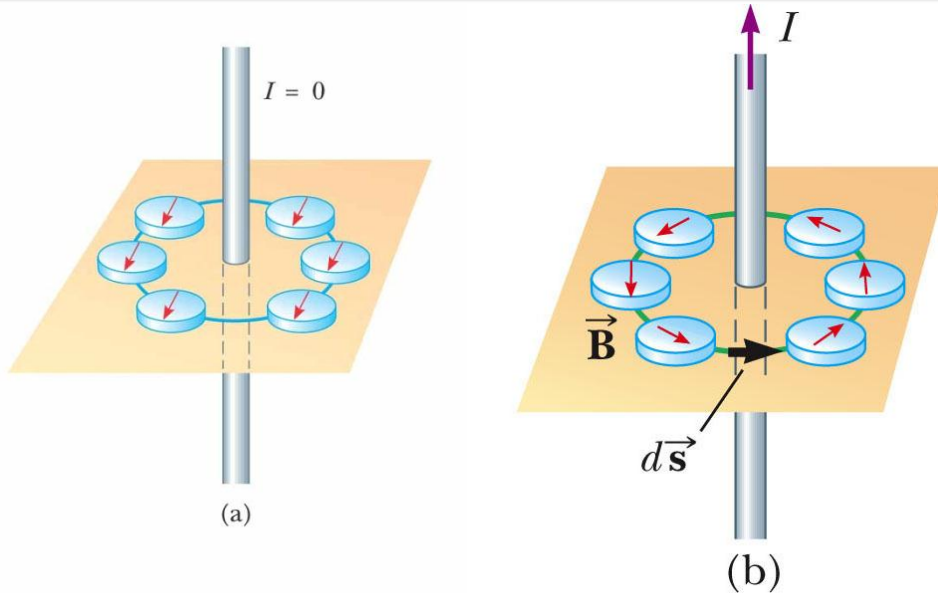

©2004 Thomson - Brooks/Cole

$$\oint \mathbf{B} \cdot d\mathbf{s} = B \oint ds = \frac{\mu_0 I}{2\pi r} (2\pi r) = \mu_0 I$$

$$\oint \vec{\mathbf{B}} \cdot d\vec{\mathbf{S}} = \mu_0 I$$

A line integral of $\mathbf{B} \cdot d\mathbf{s}$ around a closed path equals $\mu_0 I$, where I is the total continuous current passing through any surface bounded by the closed path.

Long Current Carrying Wire

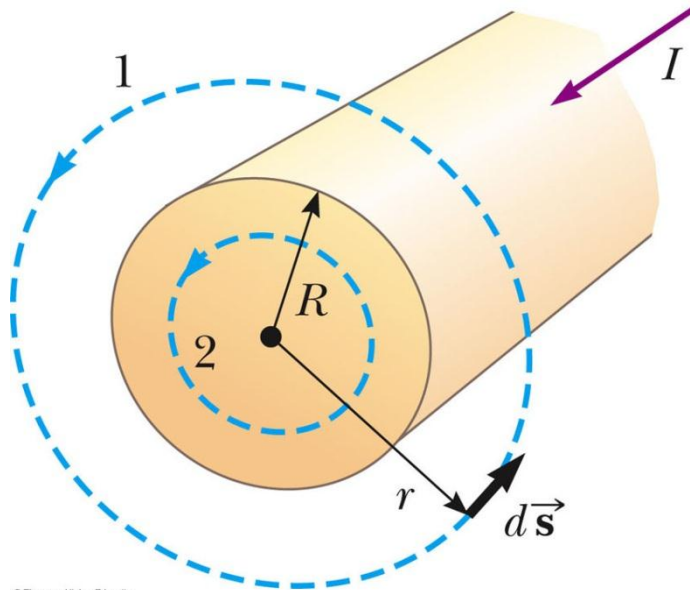

© Thomson Higher Education

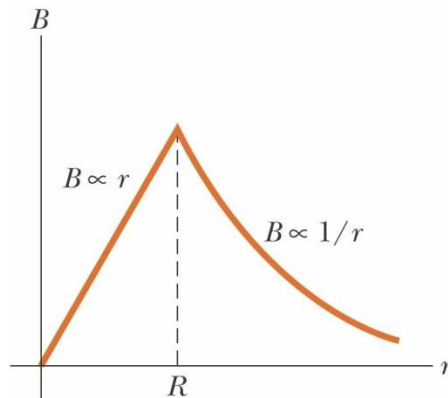

©2004 Thomson - Brooks/Cole

For $r \geq R$

$$\oint \vec{\mathbf{B}} \cdot d\vec{\mathbf{s}} = B \oint ds = B(2\pi r) = \mu_0 I$$

$$B = \frac{\mu_0 I}{2\pi r}$$

For $r < R$

$$\frac{I'}{I} = \frac{\pi r^2}{\pi R^2}$$

$$I' = \frac{r^2}{R^2} I$$

$$\oint \vec{\mathbf{B}} \cdot d\vec{\mathbf{s}} = B(2\pi r) = \mu_0 I' = \mu_0 \left(\frac{r^2}{R^2} I \right)$$

$$B = \left(\frac{\mu_0 I}{2\pi R^2} \right) r$$

The Toroid

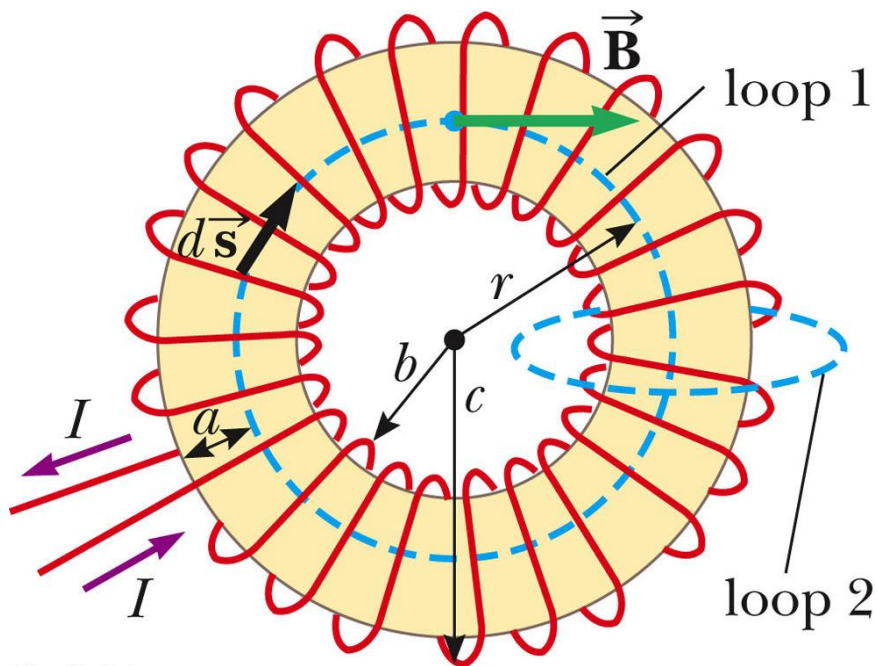

© Thomson Higher Education

By symmetry, B is constant over loop 1 and tangent to it

$$\mathbf{B} \cdot d\mathbf{s} = B ds$$

$$\oint \mathbf{B} \cdot d\mathbf{s} = B \oint ds = B(2\pi r) = \mu_0 NI$$

$$B = \frac{\mu_0 NI}{2\pi r}$$

Outside the toroid: $B \approx 0$

(Consider loop 2 whose plane is perpendicular to the screen)

The Solenoid

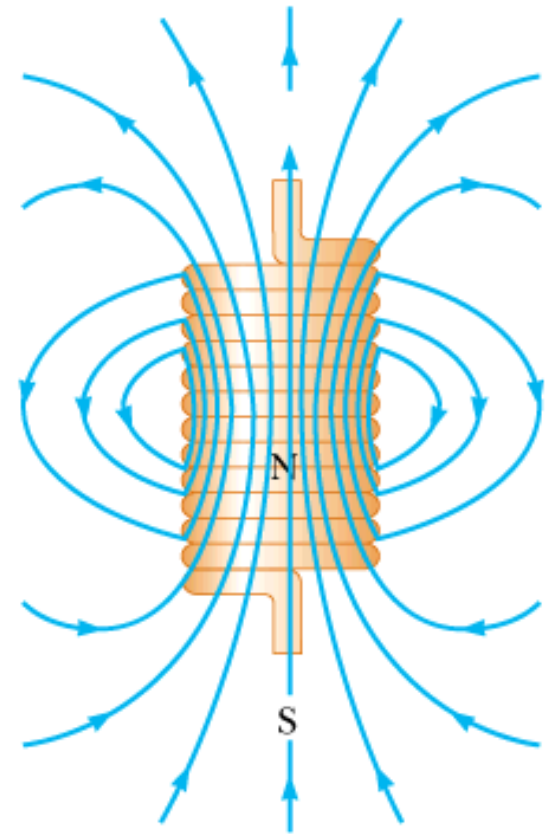
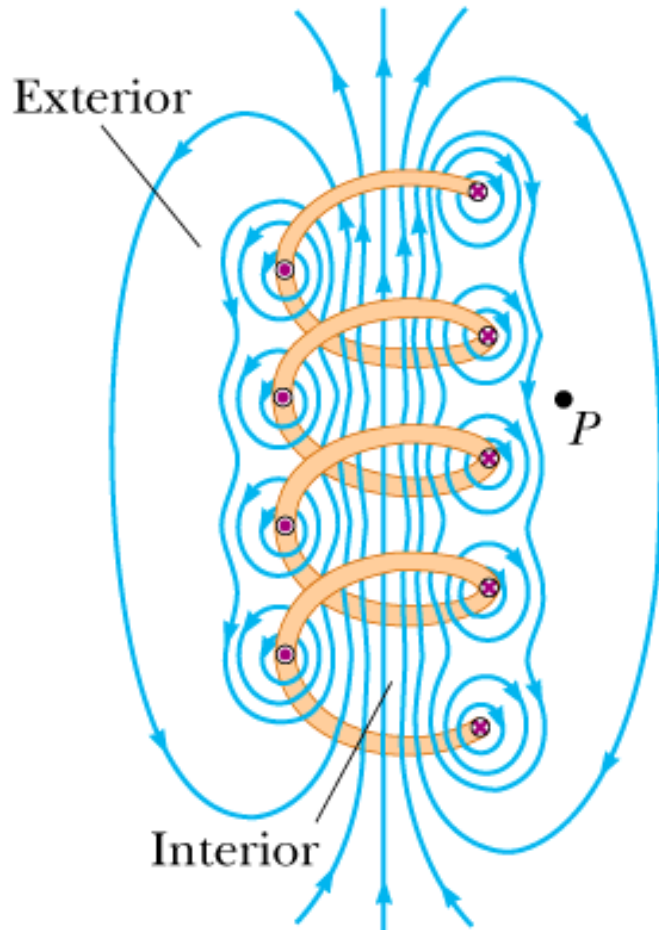

The Magnetic Field of a Solenoid

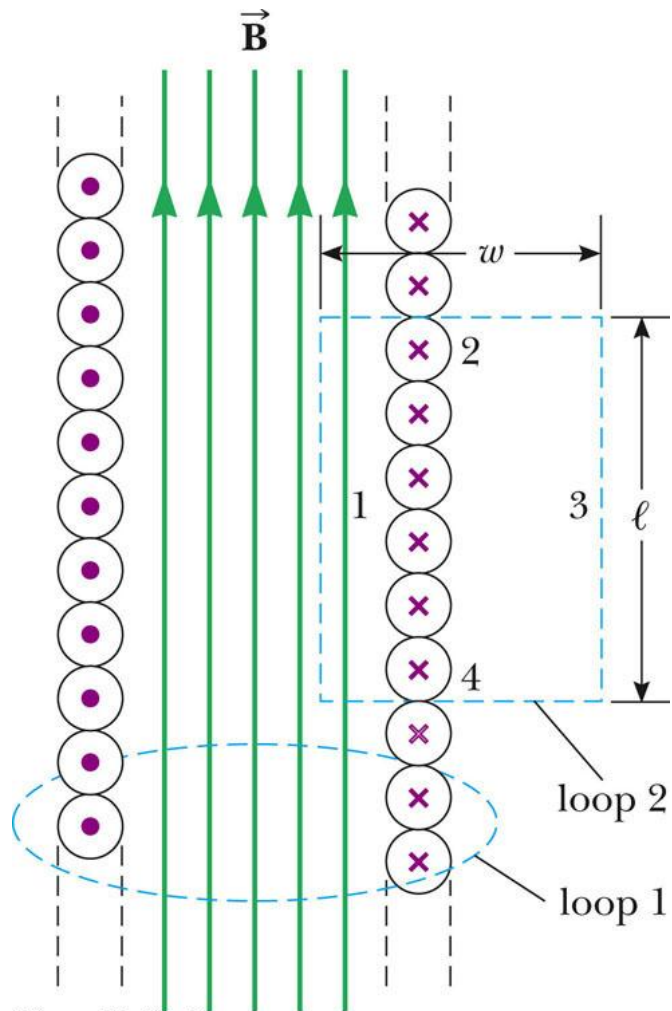

© Thomson Higher Education

Consider loop 2

Along path 2 and 4, \mathbf{B} is perpendicular to $d\mathbf{s}$

Along path 3, $\mathbf{B}=0$

$$\oint \mathbf{B} \cdot d\mathbf{s} = \int_{\text{path1}} \mathbf{B} \cdot d\mathbf{s} = B \int_{\text{path1}} ds = Bl$$

$$\oint \mathbf{B} \cdot d\mathbf{s} = \mu_0 NI$$

$$B = \mu_0 nI$$

where $n = N/l$

Magnetic Flux

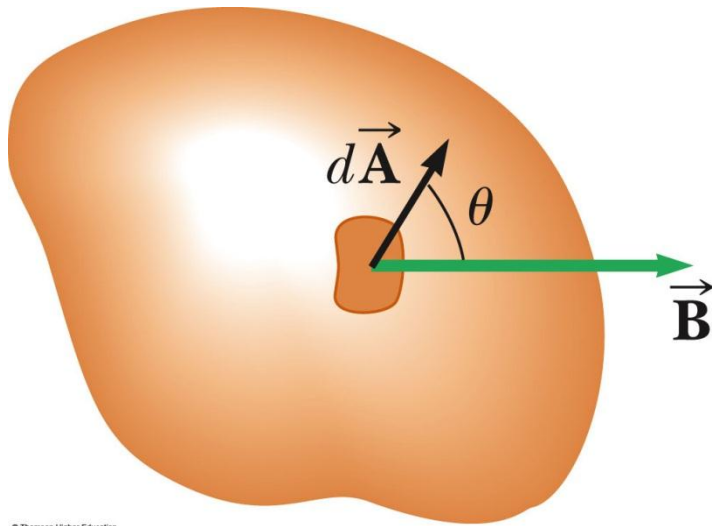

$$\Phi_B = \int \mathbf{B} \cdot d\mathbf{A} \quad (\text{Weber}=\text{Wb}=\text{T}\cdot\text{m}^2)$$

© Thomson Higher Education

For a uniform field making an angle θ with the surface normal:

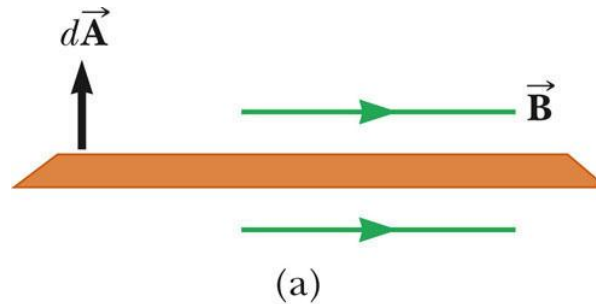

$$\Phi_B = BA \cos \theta$$

$$\Phi_B = 0$$

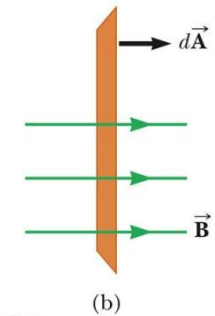

© Thomson Higher Education

$$\Phi_B = \Phi_{B,\text{max}} = AB$$

Gauss' Law in Magnetism

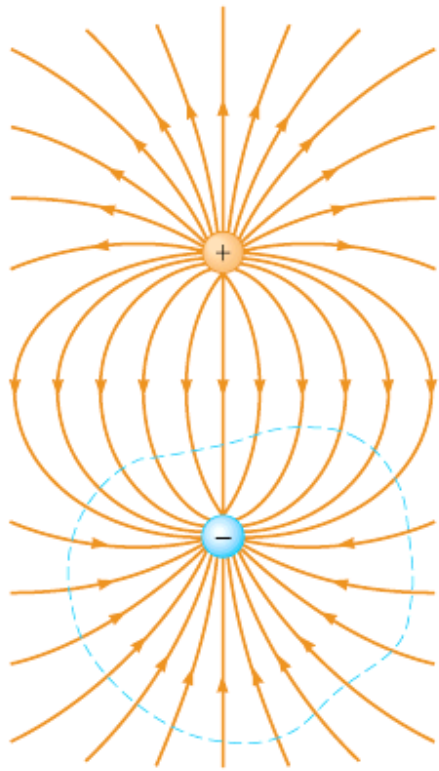

Electric Field Lines

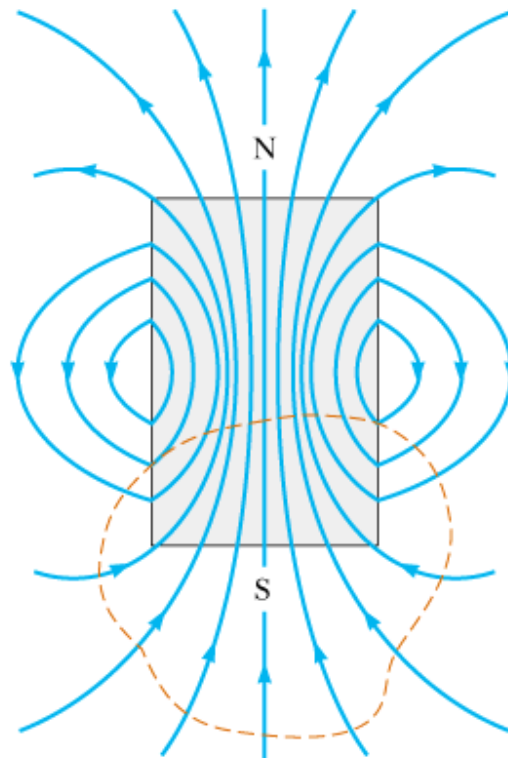

Magnetic Field Lines

Unlike electrical fields, magnetic field lines end on themselves, forming loops. (no magnetic monopoles)

$$\oint \mathbf{B} \cdot d\mathbf{A} = 0$$

Magnetic Moments of Atoms

Current carrying loop



$$B = \frac{\mu_0 I}{2R}$$

$$\vec{\mu} = I\vec{A}$$

© Thomson Higher Education

Electron in orbit

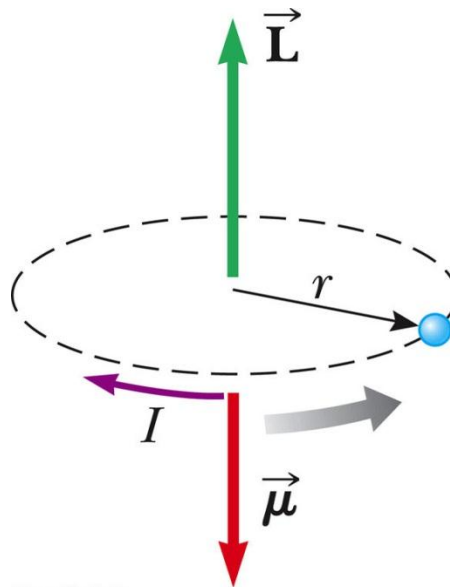

© Thomson Higher Education

$$T = \frac{2\pi}{\omega}$$

$$\omega = \frac{v}{r}$$

$$L = m_e v r$$

$$I = \frac{e}{T} = \frac{e\omega}{2\pi} = \frac{ev}{2\pi r}$$

$$\mu = IA = \frac{ev}{2\pi r} \pi r^2 = \frac{ev}{2} r$$

$$\mu = \left(\frac{e}{2m_e} \right) L = n\sqrt{2} \left(\frac{e}{2m_e} \right) \hbar$$

Electron spin

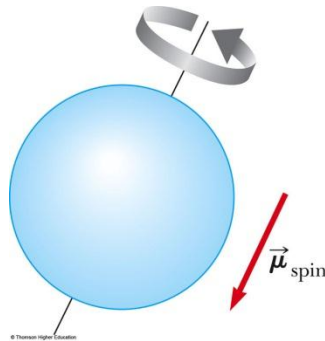

© Thomson Higher Education

$$\mu_{spin} = \left(\frac{e}{2m_e} \right) \hbar = 9.27 \times 10^{-24} \text{ J/T}$$

Magnetic Moments of Atoms

- The net orbital magnetic moment in most substances is zero or very small since the moments of electrons in orbit cancel each other out.
- Similarly, the electron spin does not contribute a large magnetic moment in substances with an even number of electrons because electrons pair up with ones of opposite spin.

Ferromagnetism

- In certain crystals, neighboring groups of atoms called domains have their magnetic moments aligned.
- A ferromagnetic crystal can be given a permanent magnetization by applying an external field.
- Examples include Fe, Co, Ni.

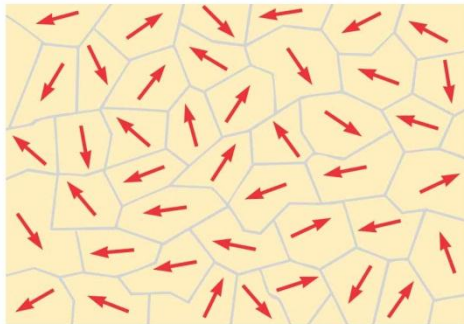

(a)

Unmagnetized crystal has domains of aligned magnetic moments.

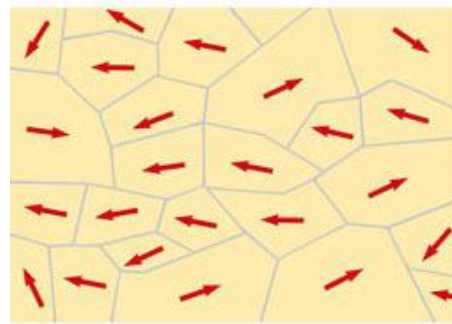

(b)

An external field increases the sizes of the domains aligned with it.

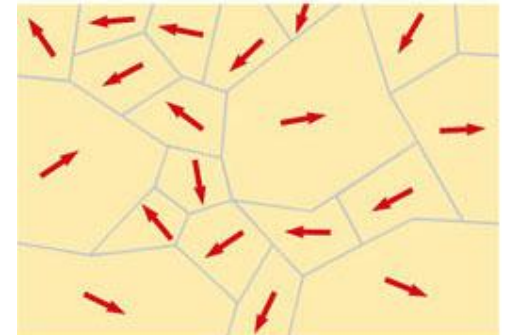

(c)

As the external field gets larger, the unaligned domains become smaller.

Paramagnetism

- Paramagnetic substances have a small but positive magnetism that comes from atoms with permanent magnetic moments.
- An external field can align these moments for a net magnetization but the effect is weak and not permanent.
- Certain organic compounds such as myoglobin are paramagnetic.

Diamagnetism

- A very small effect caused by the induction of an opposing field in the atoms by an external field.
- Superconductors exhibit perfect diamagnetism (Meissner effect).

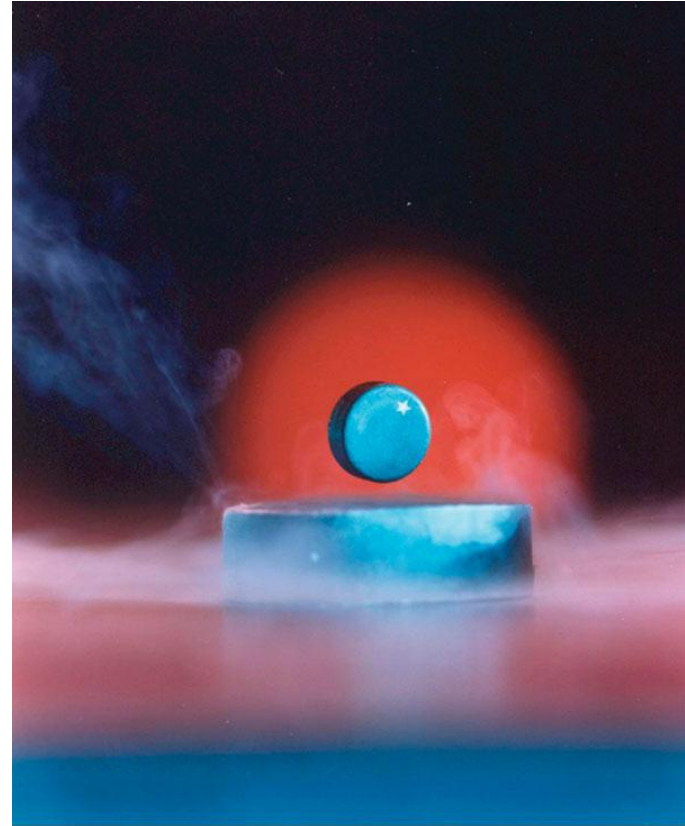

© 2004 Thomson - Brooks/Cole

Summary

- Biot-Savart Law gives the magnetic field due to a current carrying wire.
- Ampere's Law can simplify these calculations for cases of high symmetry.
- The magnetic flux through a closed surface is zero.
- Solenoids and toroids can confine magnetic fields.
- Orbital and spin magnetic moments of electrons give rise to magnetism in matter.

For Next Class

- Reading Assignment
 - Chapter 31 – Faraday's Law
- WebAssign: Assignment 8